



H<sub>2</sub>

# Sustainable control:

## RELIABLE VALVE TECHNOLOGY

Valves for hydrogen applications

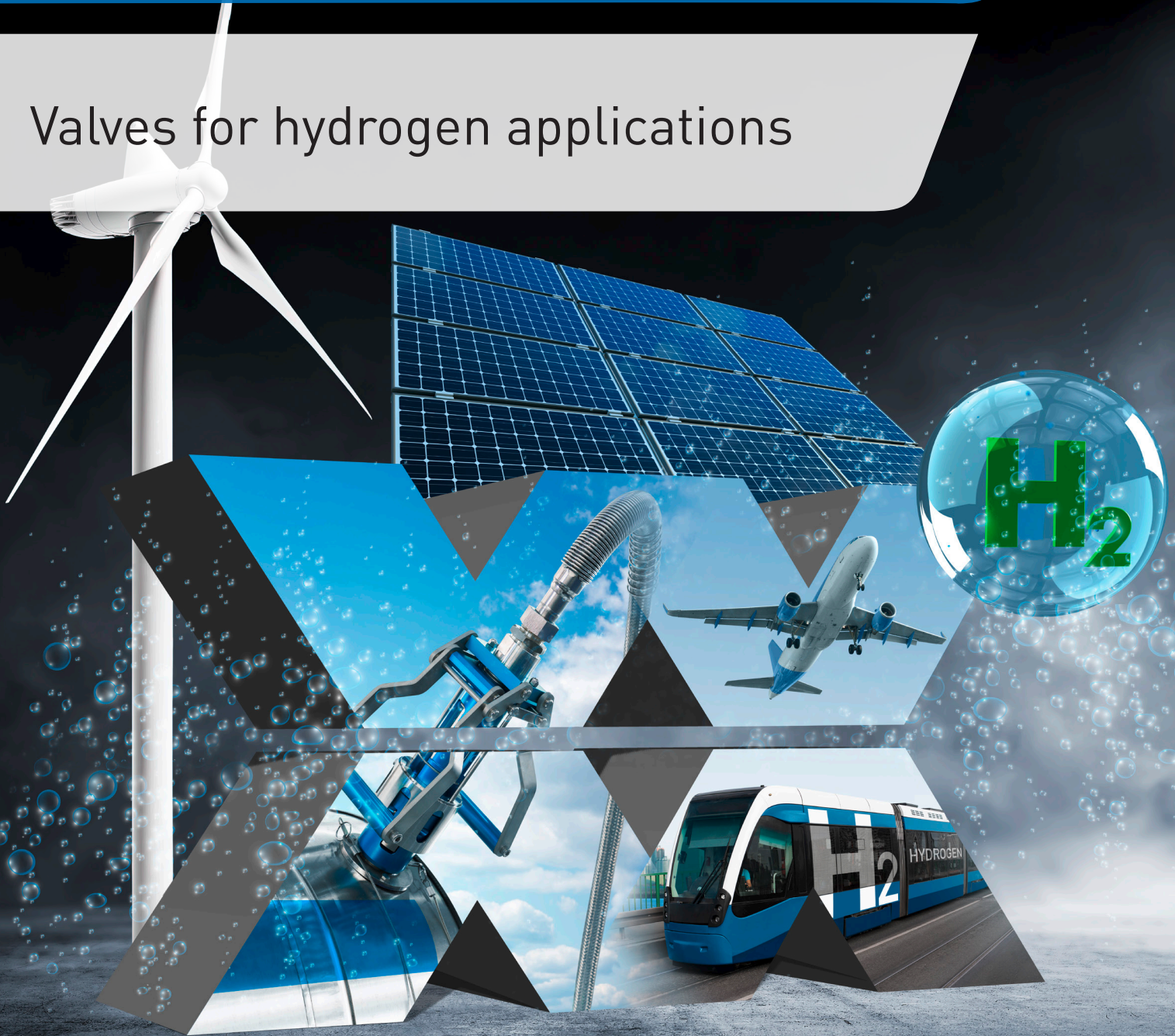

# The müller co-ax gmbh

## Your strong global partner

The müller co-ax gmbh is the world's leading valve manufacturer in the coaxial valve technology and high pressure valves. Made in Germany – developed and produced exclusively at our headquarter in Forchtenberg, our valves impress customers worldwide in various industries. With individuality, customer focus and over 60 years of market knowledge, you will experience a valve manufacturer that takes on new challenges and develops customized solutions.

Hydrogen as an alternative energy source of the future hides great potential and our valve technology helps you to exhaust this like no other can.

## coaxial valves offer many decisive advantages:

- **bi-directional operation**

The valve design allows the medium to flow through in both directions, eliminating the need for multiple valves.

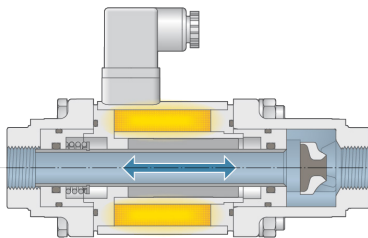

- **compact size**

The coaxial valve design provides a compact package by eliminating bulky actuators.

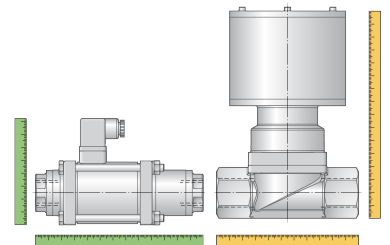

- **pressure balanced design / operating from 0 bar**

The coaxial design keeps forces within the valve balanced regardless of system pressure and delta P. The switching performance of the valve remains constant, regardless of whether vacuum or high pressures are being controlled unlike conventional valves, coaxial valves require no minimum pressure differential in order to function.

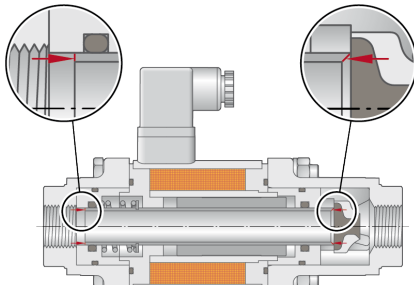

- **back pressure tight**

When the valve is closed, the pressure at the outlet side can be higher without any leakage.

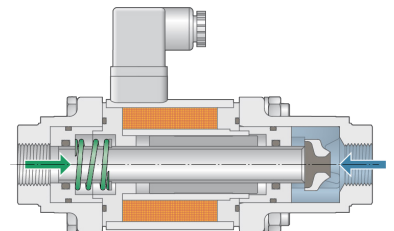





## other advantages:

- **maintenance free / resistant to dirt**
- **fast actuation**

# coax® solutions

## VALVES FOR HYDROGEN

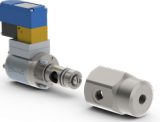
Type	Pressure range	Orifice	Kv value	Possible Applications
 KX1000	0-1000 bar	DN 8 mm	1,9 m³/h	Compressor Hydrogen Refilling stations Transport
 PCD-H 10	0-500 bar	DN 10 mm	1,5 m³/h	Hydrogen Refilling stations Test benches
 KBS 15	0-500 bar	DN 1,5-3 mm	0,066-0,312 m³/h	
 KB 15	0-400 bar	DN 2-8 mm	0,102-1,44 m³/h	
 MK/ FK	0-100 bar	DN 10-80 mm	1,6-70 m³/h	Electrolysis Pressure swing adsorption Fuel cells Gas turbines Test benches
 VMK/ VFK/ FCF/ FMX	0-200 bar	DN 8-250 mm	1,6-650 m³/h	
 Regelventil SPI	0-400 bar	DN 8-32 mm	1,6-24 m³/h	

This is an information summary. For details on the individual series, please refer to the associated data sheets.





## Pneumatic actuated coaxial valves (3/2 version)

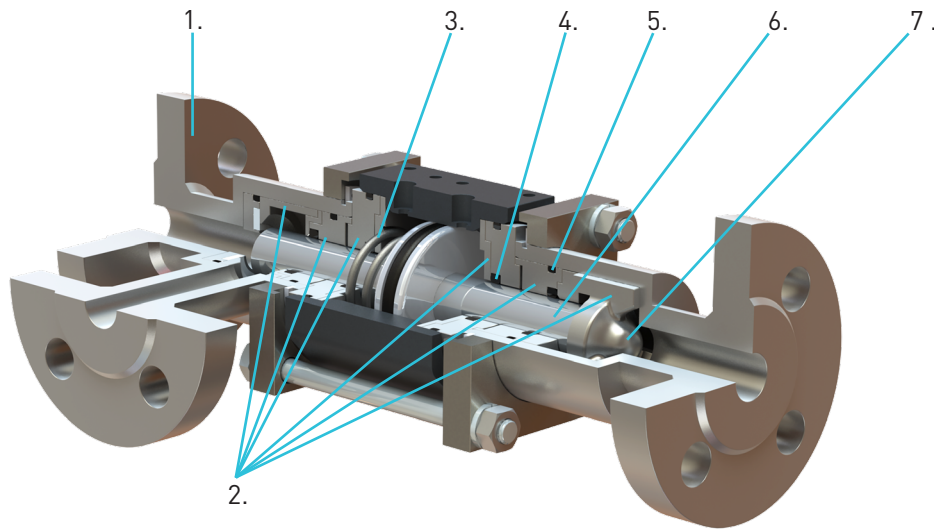

## Solenoid actuated coaxial valves (2/2 version)

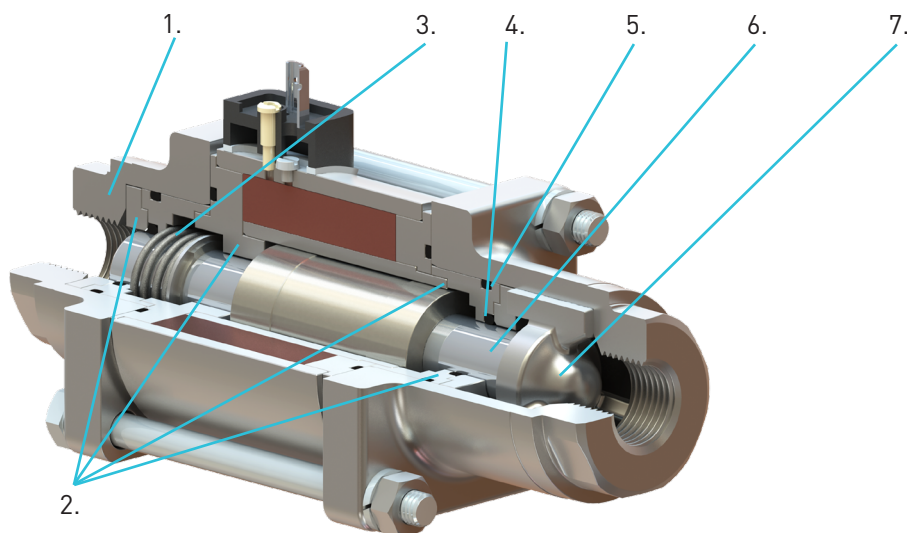

Components for coaxial valves with 2 or 3 port connections

Item:	Material number (DIN)	AISI:
1. valve port	1.4581 or 1.4404 or 1.4571	316L or 316Ti
2. all media touched inner parts	1.4404	316L
3. return spring	1.4310	301
4. all dynamic seals	PTFE or FPM (Viton)	
5. all static seals	FPM (Viton)	
6. control tube	1.4404 or 1.4301	316L or 304
7. valve seat	PTFE or FPM (Viton)	



H<sub>2</sub>

## Size comparison - space-saving in flexible modular bodies

Ball valve



[5]-FCF-K series  
(interchangeable „short“  
version without limit switch)

interchangeable

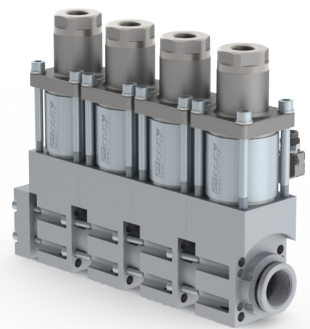

### Features of the coaxial valves - solenoid actuated

- Valves technically tight to the atmosphere, even if the seals are worn (closed design, tightness guaranteed, no open connection, no hazardous substance leakage/skin contact).
- Standard voltage 24V DC / 230V AC
- Special voltages on request
- available options:
  - with limit switch (direct indication OPEN/CLOSE)
  - mounting bracket
  - terminal box
  - device connector e.g. M12\*1 VDMA/DESINA
  - manual override
- Medium temperature range
  - f. Standard version: from -20°C to +100°C  
optionally from -40°C to 160°C\*
  - f. Ex-Zone 1 equipment category 2 from -20°C to +40°C\*
  - f. Ex-Zone 2 equipment category 3 from -20°C to +80°C\*
  - f. IECEx: from -30°C to +50°C \* [only orifice DN10]
  - f. DVGW: from -15°C to +80°C \* [only orifice DN15 to 25]

### Features of the coaxial valves - general

- Compact and small design
- Valves with flow on both sides
- Very fast switching times
- Valve connection optionally in:
  - Flange (e.g. DIN EN 1092-1)
  - Socket version (e.g. SAE / NPT thread)
  - Weld end
- SIL 2 as standard, SIL 3 optional
- MTF values on request

### Features of the coaxial valves - pneumatically actuated

- 5/2-pilot valve – direct or externally mounted
- All valves switch from 3 bar control air pressure
- Pilot air consumption 1/10 of a ball valve
- Leakage hole with drainage connection
- Limit switch (direct indication OPEN/CLOSE)
- Mounting bracket
- Medium temperature range: from -20°C to +60°C  
optional from -40° to 160°C (pilot external)\*
- Ex zone 1 – max. temperature from -20°C to +160°C\*

[\*] Depending on the temperature range, there may be adjustments to the desired valve configuration



[www.co-ax.com](http://www.co-ax.com)

All technical information was accurate as of the time of printing. We reserve the right to make technical modifications. Unfortunately, it is not possible to exclude all errors. Please be aware that the information, images and descriptions provided cannot serve as the basis for any legal claims. The text, photos, technical drawings and any other representations included in this publication are the protected property of müller co-ax gmbh. Any further use shall require the express approval of müller co-ax gmbh.



We reserve the right to make technical modifications.

H\_1/0824\_en

müller co-ax gmbh  
Friedrich-Müller-Straße 1  
74670 Forchtenberg  
Germany  
Tel: +49 7947 828-0  
[info@co-ax.com](mailto:info@co-ax.com)